

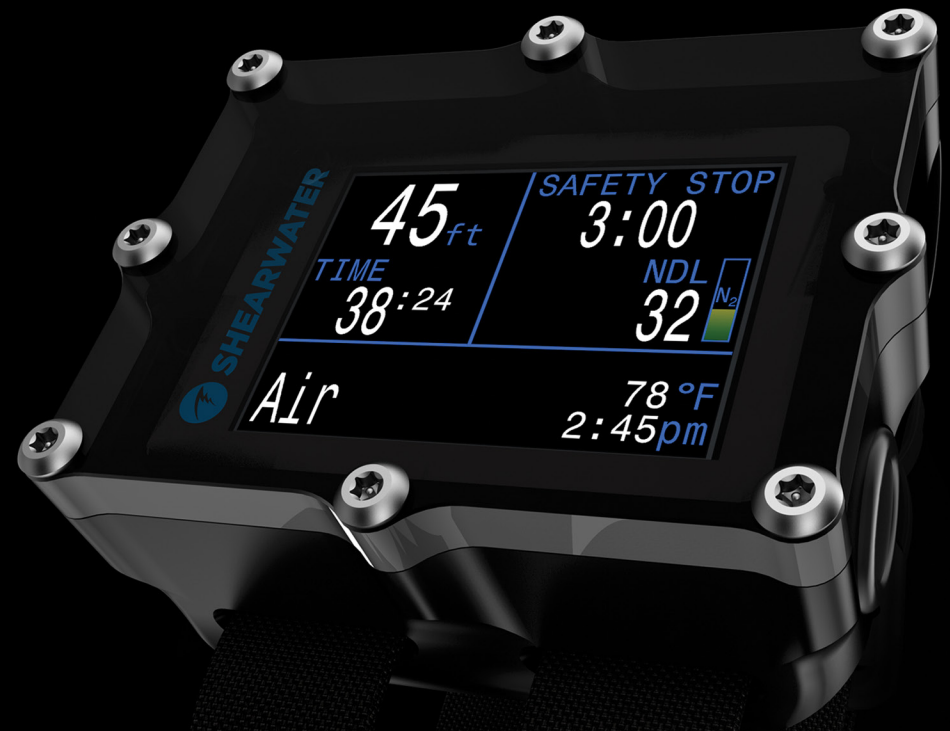

# **SHEARWATER** **PETREL**

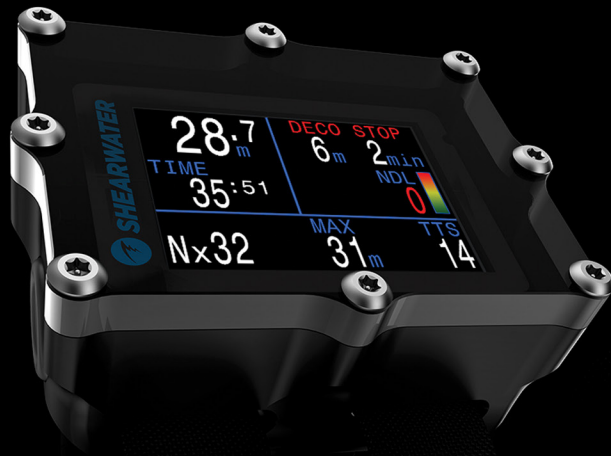

**Nitrox Recreational Mode**

**Petrel 1 / Petrel 2**

**User Manual**



**Powerful • Simple • Reliable**



# Table of Contents

Table of Contents .....	2
Conventions Used in this Manual .....	3
<b>1. Introduction.....</b>	<b>4</b>
1.1. Features .....	4
<b>2. Modes Covered by this Manual.....</b>	<b>5</b>
<b>3. Buttons .....</b>	<b>6</b>
3.1. Turning the Petrel On .....	6
3.2. Button Labels .....	6
<b>4. The Main Screen.....</b>	<b>7</b>
4.1. Basic Dive Info .....	7
4.2. Decompression Info.....	7
4.3. Configurable Bottom Row .....	7
4.4. Detailed Descriptions.....	8
<b>5. Info Screens .....</b>	<b>10</b>
5.1. Info Screen Detailed Descriptions .....	10
5.2. Compass (Petrel 2 only).....	13
<b>6. Safety and Decompression Stops .....</b>	<b>14</b>
6.1. Safety Stop.....	14
6.2. Decompression Stops .....	15
<b>7. Menu Reference .....</b>	<b>16</b>
7.1. Turn Off .....	17
End Dive.....	17
7.2. Select Gas.....	17
7.3. Dive Setup+ .....	17
Define Gas .....	17
NDL Planner+.....	17
Dive Planner+ .....	17
Brightness .....	17
7.4. Dive Log+ .....	18
Display Log .....	18
Upload Log.....	18
Edit Log Number .....	18
Clear Log.....	18

<b>8. System Setup+ .....</b>	<b>18</b>
8.1. Dive Setup.....	18
Mode .....	18
8.2. Deco Setup.....	19
Conservatism .....	19
Safety Stop.....	19
8.3. Bottom Row .....	19
8.4. Nitrox Gases .....	20
8.5. Display Setup .....	20
Units .....	20
Brightness .....	20
Altitude .....	20
Flip Screen.....	20
8.6. Compass Setup (Petrel 2 only) .....	21
Compass View .....	21
True North .....	21
Calibrate.....	21
8.7. System Setup .....	22
Date & Time .....	22
Unlock .....	22
Load Upgrade .....	22
Reset to Defaults.....	22
8.8. Adv. Config.....	22
Main Color.....	22
Title Color .....	22
End Dive Delay .....	22
Bat Icon .....	22
Max. Depth.....	22
<b>9. Changing the Battery .....</b>	<b>23</b>
9.1. Battery Types .....	23
9.2. Tissues Cleared .....	24
<b>10. Storage and Maintenance .....</b>	<b>25</b>
<b>11. Servicing.....</b>	<b>25</b>
<b>Glossary .....</b>	<b>25</b>
<b>Specifications .....</b>	<b>26</b>
FCC Warning.....	26
Industry Canada Warning .....	26



## DANGER

This computer is capable of calculating deco stop requirements. These calculations are at best a guess of the real physiological decompression requirements. Dives requiring staged decompression are substantially more risky than dives that stay well within no-stop limits.

**Diving with rebreathers and/or diving mixed gases and/or performing staged decompression dives and/or diving in overhead environments greatly increases the risk of scuba diving.**

**You really are risking your life with this activity.**

## WARNING

This computer has bugs. Although we haven't found them all yet, they are there. It is certain that there are things that this computer does that either we didn't think about, or planned for it to do something different. Never risk your life on only one source of information. Use a second computer or tables. If you choose to make riskier dives, obtain the proper training and work up to them slowly to gain experience.

This computer will fail. It is not whether it will fail but when it will fail. Do not depend on it. Always have a plan on how to handle failures. Automatic systems are no substitute for knowledge and training.

No technology will keep you alive. Knowledge, skill, and practiced procedures are your best defense (except for not doing the dive, of course).

## Conventions Used in this Manual

These conventions are used to highlight important information:



### INFORMATION

Information boxes contain useful tips for getting the most out of your Petrel.



### CAUTION

Caution boxes contain important instructions on operating the Petrel.



### WARNING

Warning boxes contain critical information that may affect your personal safety.



# 1. Introduction

The Shearwater Petrel is an advanced dive computer for all types of diving. This manual covers operation of the Nitrox Recreational Mode.

Please take the time to read this manual. Your safety may depend on your ability to read and understand the Petrel displays.

Do not use this manual as a substitute for proper dive training and never dive beyond your training. What you don't know can hurt you.

## 1.1. Features

- Up to 3 Nitrox gases (includes Air)
- Clear layout optimized for Air and Nitrox diving
- Optional safety stops
- Nitrogen loading bar graph
- Configurable bottom row
- No-Decompression Limit (NDL) planner
- Bühlmann ZHL-16C with gradient factors deco model
- Decompression planner
- Maximum operating depth warnings
- Switchable to technical open and closed circuit modes
- Up to 1000 hours of on-board dive log
- Bluetooth for dive log uploads and firmware updates



### Petrel 1 vs. Petrel 2

This manual covers both the Petrel 1 and Petrel 2 models. The differences are that the Petrel 2 has a digital compass and also supports Bluetooth Smart for connection to iOS devices. Both models have Bluetooth Classic for connection to desktop computers, laptops, and Android devices.

All other features are the same between the Petrel 1 and Petrel 2. Both models use the same firmware file and firmware version number.



### All dives have a risk of DCI

It is important to understand that all dives come with the risk of decompression illness (DCI), even dives staying well within no-decompression limits.

No dive computer or decompression model can guarantee a zero risk of DCI. Education and following established procedures are your best defenses.

We recommend carrying dive insurance and having a plan to deal with emergencies.



## 2. Modes Covered by this Manual

This manual only covers operation of the Shearwater Petrel in the Nitrox Recreational Mode (OC Rec).

The Shearwater Petrel also has modes for technical diving with trimix and rebreather diving.

Please see the document *Shearwater Petrel Operations Manual, Stand Alone & EXT Models* for instructions on these technical modes.

Use the *System Setup* → *Dive Setup* menu to set the Mode to OC Rec, which stands for “Open Circuit Recreational”.

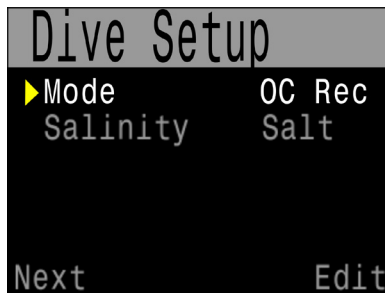

FIGURE 1 Setting OC Rec Mode



### Switching between Rec and Tec modes

You may safely switch between Rec and Tec modes with no penalty, as all decompression tissue loading is retained (except when switching to Gauge mode).



FIGURE 2 The Nitrox Recreational Mode is optimized for Air and Nitrox diving

Other Tec modes (not covered by this manual) are:

The OC Tec mode allows up to 5 trimix gases (air and nitrox can be used as well).

It provides more control over settings, but also more opportunities for mistakes and is more complex.



FIGURE 3 OC Tec Mode



FIGURE 4 OC/CC Mode

The OC/CC mode is for closed circuit rebreather divers. Open circuit is available for bailout.

The SA model uses fixed PPO2 setpoints, while the EXT Model allows both fixed setpoints and monitoring PPO2 from external sensors.

Gauge Mode provides a simple bottom timer without decompression calculations.

It features maximum and average depth (average is resettable) and a stopwatch for ratio deco divers.



FIGURE 5 Gauge Mode



### 3. Buttons

The Petrel is operated by two piezo-electric buttons (FIGURE 6). They are completely sealed and have no moving parts.

The left button is the MENU button and the right button is the CONFIRM button.

All operations are simple single presses.

There are no complex hold patterns, simultaneous presses or multiple taps needed.

#### 3.1. Turning the Petrel On

OK, we lied. There is one situation where a simultaneous button press is needed.

**i Turning On**

Press both buttons at the same time to turn on.

Other than that, only single button presses are needed (we promise).

#### 3.2. Button Labels

Button labels (FIGURE 7) make using the Petrel easy.

When in a menu, the function of each button is labeled.

This means there is no need to memorize button functions, just refer to the label if you get confused.

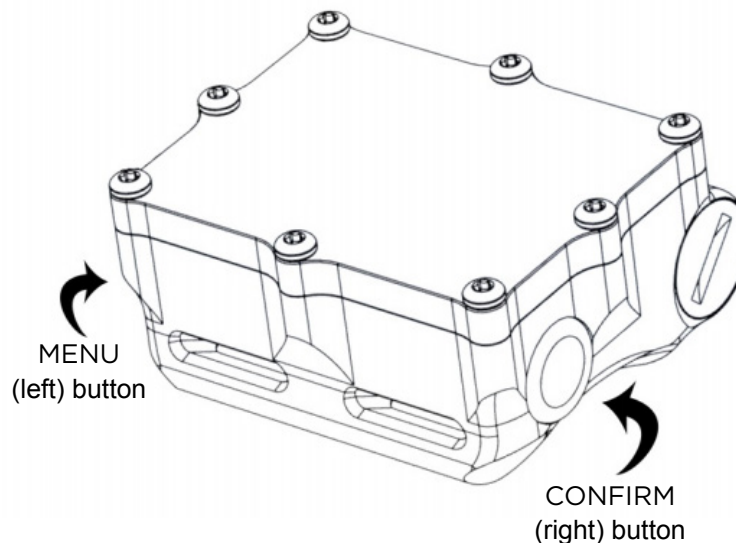

FIGURE 6 **Petrel Buttons**

Two piezo-electric buttons operate the Petrel. Most operations are simple, single button presses, except for turning on which requires pressing both buttons at the same time.

Labels indicate the function of each button.

In this example, the left button changes the brightness setting, while the right button saves the changes.



FIGURE 7 **Button Labels**



## 4. The Main Screen

The Main Screen (FIGURE 8) shows the most important information for Air and Nitrox diving.

It is divided into three sections: Basic dive info, decompression info, and the configurable bottom row.

### 4.1. Basic Dive Info

The Basic Dive area shows:

- The current depth (in feet or meters)
- The dive time in minutes and seconds

When on the surface, the dive time is replaced by a surface interval timer. Also, a battery gauge will appear in this area.

### 4.2. Decompression Info

The Decompression area shows:

- Safety stops (if enabled)
- Decompression stops
- No-Decompression Limit (NDL) in minutes
- Nitrogen loading bar graph
- Warnings for maximum operating depth (MOD) and CNS

### 4.3. Configurable Bottom Row

The bottom-left position always shows the currently selected gas.

The center and right positions can be configured to show a variety of different displays. See the [System Setup](#) ⇒ [Bottom Row](#) menu for options.



FIGURE 8 *The Main Screen*

The exact appearance of the main screen may vary slightly.

For example, here the depth is shown in meters, a customized bottom row is used, and the safety stop has been replaced by a mandatory decompression stop.

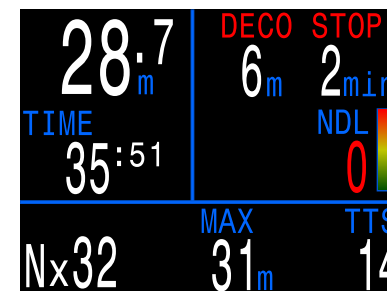

FIGURE 9 *Alternate View of the Main Screen*





## 4.4. Detailed Descriptions

The following describes each main screen display in detail.

### Basic Dive Info Area

#### Depth

The depth is shown in the top left. When in meters, one decimal place is shown.

Beside the depth, the ascent rate is shown as a series of up arrows. Each arrow is 10 ft/min or 3m/min. e.g.

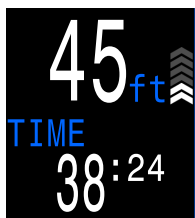
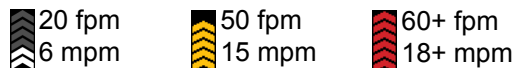

FIGURE 10  
**Depth in Feet and Dive Time**

#### Dive Time

Dive time displays in minutes and seconds. It begins and ends counting automatically when you dive.

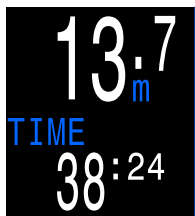

FIGURE 11  
**Depth in Meters Shows One Decimal**

#### Surface Interval

When on the surface, the dive time is replaced by the surface interval in hours and minutes. Beyond 96 hours (4 days), it displays in days.

The surface interval is reset to zero whenever the decompression tissues are cleared.



FIGURE 12  
**Surface Interval and Battery Symbol**

#### Battery Symbol

Replace the battery when yellow or red. The battery symbol only appears when on the surface or when the battery is low. In Adv. Config. this behaviour can be changed.

### Decompression Info Area

#### Safety Stop

Counts down automatically when in the safety stop range.

See the Stops section for details.

Safety stops may be turned off, set to fixed times of 3, 4, or 5 minutes, or set to adapt based on dive conditions. See the System Setup → Dive Setup menu.



FIGURE 13  
**Safety Stop**

#### Deco Stop

Safety Stop will be replaced with Deco Stop when mandatory decompression stops are required.

See the Stops section for important details.



FIGURE 14  
**Deco Stop**

#### No-Decompression Limit (NDL) Time

The NDL is the time, in minutes, that may be spent at the current depth until decompression stops will be needed.

A maximum value of 99 minutes is displayed.

Displays in yellow when less than 5 minutes, and red when decompression stops are needed.





## Decompression Info Area

(continued)

### Nitrogen Loading Bar Graph

The nitrogen bar graph is scaled such that it is full once decompression stops will be needed.

On the surface, it shows the residual nitrogen from the previous dive.



FIGURE 15  
**N<sub>2</sub> Bar Graph**

### Warnings

This area also shows the following warning displays. Listed from highest to lowest priority. If multiple warnings, only the highest priority will display.

#### High CNS

Central Nervous System (CNS)  
Oxygen Toxicity limit reached.

#### MOD, go up

Maximum Operating Depth (MOD)  
exceeded. Ascend to shown depth.

#### MOD, switch gas

Maximum Operating Depth (MOD)  
exceeded. Switch to more appropriate  
gas (another gas must be programmed  
and turned on for this to appear).

#### Near MOD

Within 5ft (1.9m) below MOD. Just a  
notification, no action required.

#### Better Gas

Another gas is programmed that is  
more suitable at the current depth.  
Only displays when deco stops are  
needed.

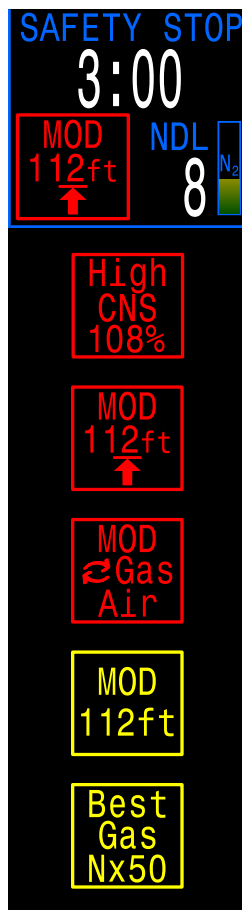

FIGURE 16  
**Warnings**

## Configurable Bottom Row

### Gas

The gas position is not configurable. It shows the currently selected breathing gas.

When air (21% O<sub>2</sub>) is used, the value "Air" is displayed. For all other gases, it displays "Nx" (Nitrox) followed by the O<sub>2</sub>%.

The gas will flash red if the maximum operating depth (MOD) of the gas is exceeded. It will display in yellow if a better gas is available.

Air

Nx32

FIGURE 17  
**Currently Selected Gas**

### Configurable Center & Right Positions

Many possible configurations can be set for the center and right positions of the bottom row. A few possible setups are shown below.

See System Setup⇒Bottom Row for descriptions of all options.

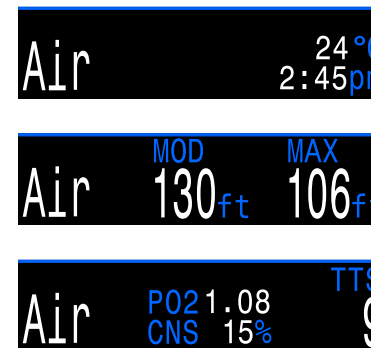

FIGURE 18 **Example Configurations for the Bottom Row**



## 5. Info Screens

Info screens (FIGURE 19) provide more information than is available on the main screen.

The info screens only replace the bottom row, keeping the other information visible at all times.

Press the CONFIRM (right) button to step through the info screens.

Return to the main screen by:

- Pressing the MENU (left) button.
- Waiting 10 seconds for the info screen to time out.
- Scrolling past the last info screen.

### 5.1. Info Screen Detailed Descriptions



#### MOD

Maximum operating depth of the current gas. Determined as the shallower of the MOD PPO2 limit and the Max. Depth setting. Displays in flashing red when exceeded.

#### MAX

The maximum depth reached in the current dive. When on the surface, the maximum depth of the previous dive.

#### PPO2

Partial pressure of oxygen of the current gas in units of absolute atmospheres [ata]. Displays in flashing red when the MOD PPO2 setting is exceeded.



- Return to Main Screen by:
- Pressing MENU (left) button
  - Waiting 10 seconds
  - Stepping past last screen

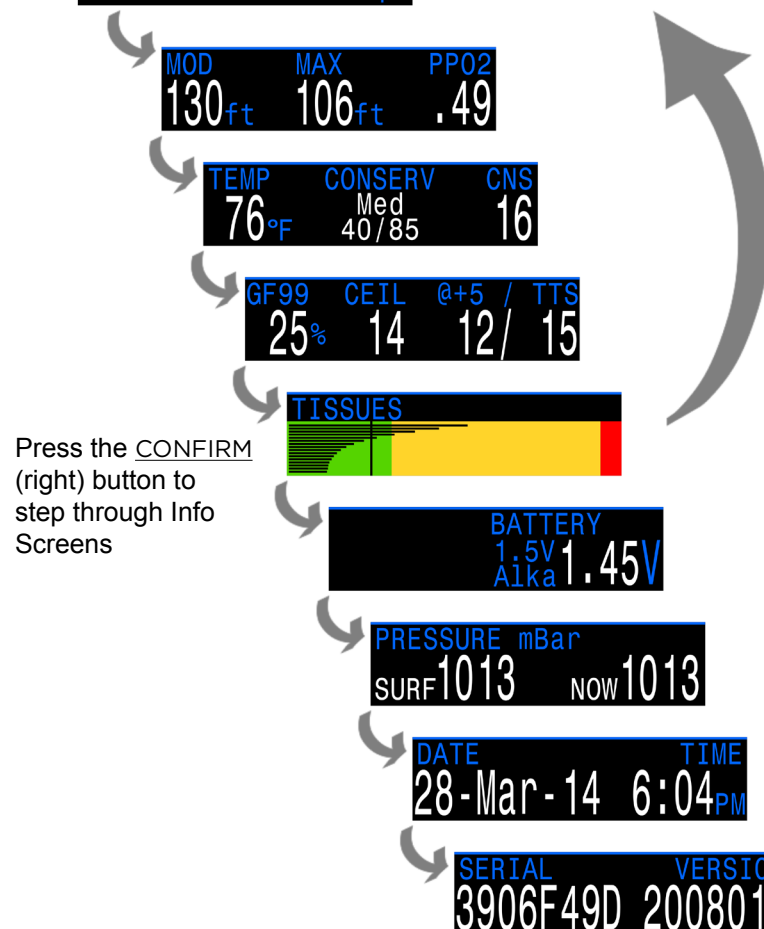

FIGURE 19 **Info Screens Display Extra Information Not Available on the Main Screen**



TEMP	CONSERV	CNS
76°F	Med 40/85	16

### TEMP

The current temperature. In °F when units are feet or °C when units are meters.

Note that case case insulates the temperature sensor, so allow 10 to 15 minutes for the temperature to reach the actual environmental temperature.

### CONSERV

The current conservatism setting of the Bühlmann ZHL-16C with gradient factors.

Shows the setting (Low, Med, High), along with the actual gradient factor corresponding to this setting.

See System Setup⇒Deco Setup for more information.

### CNS

Central Nervous System oxygen toxicity limit as a percentage.

Displays in red when greater than 90%.



#### Oxygen Toxicity Limits

Much like decompression, oxygen toxicity limits are not an exact science, but rather best guidelines for reducing risk to acceptable limits.

The consequences of seizures due to oxygen toxicity when diving are severe. For recreational nitrox diving, we recommend never exceeding a PPO2 of 1.4 ata.

GF99	CEIL	@+5 / TTS
25%	14	12 / 15

### GF99

The gradient factor as a percentage (i.e. super-saturation percent gradient).

0% means the leading tissue super-saturation is equal to ambient pressure. Displays “On Gas” when tissue tension is less than the inspired inert gas pressure.

100% means the leading tissue super-saturation is equal to the original M-Value limit in the Bühlmann ZHL-16C model.

Displays in yellow when the current gradient factor modified M-Value is exceeded. Displays in flashing red when 100% is exceeded.

### CEIL

The current decompression ceiling not rounded to next deeper stop increment (i.e. not a multiple of 10ft or 3m).

### @+5 / TTS

“At plus 5” is the TTS, in minutes, if remaining at the current depth for 5 more minutes.

Shown along with TTS, since it only has meaning when compared with TTS. This can be used as a measure of how much you are on-gassing or off-gassing.



**TISSUES**

The tissues bar graph shows the tissue compartment inert gas tissue tensions based on the Bühlmann ZHL-16C model.

The fastest tissue compartment is shown on the top, and the slowest on the bottom. Pressure increases to the right.

The vertical black line shows the inert gas inspired pressure. The boundary between the green and yellow zones is the ambient pressure. The boundary between the yellow and red zone in the original ZHL-16C M-Value pressure.

NOTE: This tissues graph displays similar info to the main screen N<sub>2</sub> bar graph, but they are not the same. This graph shows the *current* tissue loads for all compartments. The main screen display shows only the leading compartment, *after ascent to the surface*.

**Some Sample Tissues Graphs**



On surface (sat. with air)



After descent



On-gassing



Deep stop



Last deco stop

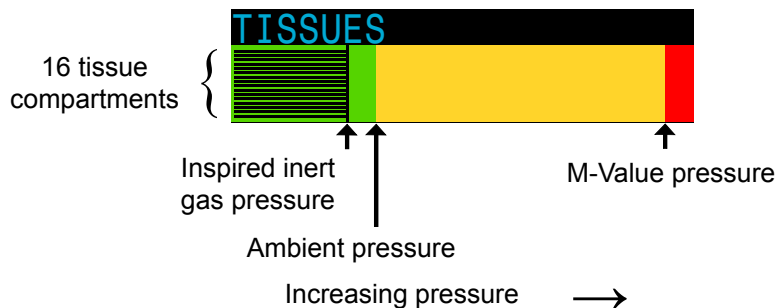

**BATTERY**

The battery type and voltage.

Battery type can only be set when the battery is changed.



**Ensure Battery Type Matches Actual**

The voltage levels for low battery warnings are different for each type of battery.

For this reason it is important that the battery type setting is correct. Otherwise the Petrel may not warn properly and the battery may die unexpectedly.



**PRESSURE mBar**

Displays the value being used as the surface pressure (SURF) in millibars, as well as the current pressure (NOW). The NOW value is only displayed when on the surface.

Note that typical pressure at sea level is 1013 millibar, although it may vary with the weather (barometric pressure). For example, in a low pressure system the surface pressure may be as low as 980 millibar, or as high as 1040 millibar in a high pressure system.

For this reason, the displayed PPO<sub>2</sub> on the surface may not exactly match the FO<sub>2</sub> (fraction of O<sub>2</sub>), although the displayed PPO<sub>2</sub> is still correct.



## 5.2. Compass (Petrel 2 only)

The Petrel 2 model contains a tilt-compensated digital compass.

### Compass Features

- 1° resolution
- ±5° accuracy
- Smooth, high-speed refresh rate
- Heading with reciprocal
- True North (declination) adjustment
- Tilt compensation ±45°



### Viewing the Compass

When enabled, the compass is viewed by pressing the SELECT (right) button once. Press SELECT again to continue on to view the regular info screens.

Unlike the regular info screens, the compass never times out back to the main screen. Press MENU (left) button to return to the main screen.



### Compass Limitations

It is important to understand some compass limitations before use.

**Calibration** - The digital compass needs occasional calibration. This can be done in the **System Setup** → **Compass** menu and takes only one minute.

**Battery Changes** - When the battery is changed, the compass should be calibrated to compensate for the steel case.

**Interference** - Since a compass operates by reading the Earth's magnetic field, the compass heading is affected by anything that distorts that field or creates its own. Steel objects and electric motors or cabling (e.g. from dive lights) should be kept at a distance. Being close to or inside a shipwreck may also affect the compass.

### Marking a Heading

To mark a heading, press MENU (left) button until "Mark Compass" is displayed, then press SELECT (right) button to mark the current direction. The display will then jump back to the compass display. The heading is shown as a pair of green triangles.



Mark the heading to remember the current direction



This feature makes it easy to determine if you are off course



When the marked heading is off screen, an arrow points the shortest way back



When facing the opposite direction, the reciprocal heading is shown as a pair of red triangles

Only one heading can be marked at a time, it can however be changed. Once a heading has been marked, there is no way to clear the heading arrows from the display.



## 6. Safety and Decompression Stops

Safety and decompression stops are pauses inserted into the ascent to the surface in order to reduce the risk of decompression illness (DCI).

### 6.1. Safety Stop

A safety stop is an optional stop added to all dives before surfacing. Safety stops can be set to fixed times of 3, 4, or 5 minutes, set to adapt based on dive conditions, or turned off completely. See System Setup → Deco Setup for options.

The Petrel does not do “deep safety stops”. That is, there are no extra stops added around 50ft to 60ft (15m to 18m) when ascending from a no-deco dive.

Safety stops behave as follows:

#### Safety Stop Required

Once the depth exceeds 35ft (11m), a safety stop will be added.



#### Automatic Countdown

Countdown begins once the depth becomes shallower than 20ft (6m). Countdown will continue while the depth remains in the range of 7ft to 23ft (2.4m to 7.0m).



#### Countdown Paused

If the depth goes outside of the range 7ft to 23ft (2.4m to 7.0m), then the countdown pauses, and the display instructs to either an ascend or descend.



#### Safety Stop Complete

When the countdown reaches zero, the display changes to “Complete” and you are now clear to ascend to the surface.



#### Countdown Reset

The countdown will reset if the depth once again exceeds 35ft (11m).



#### No lock-out for omitting safety stop

There is no lock-out or other penalty for omitting a safety stop, as they are optional.

If you ascend to the surface before the safety stop countdown finishes, you will get a flashing yellow descend arrow, but this will disappear once the dive ends.

We recommend performing safety stops as planned as they offer a reduction in risk of DCI and take little time.



## 6.2. Decompression Stops

Decompression stops are mandatory stops that must be followed in order to reduce the risk of decompression illness (DCI).



### Do not dive beyond your training

Only perform decompression diving if you have received proper training to do so.

Diving with any type of overhead ceiling, whether in a cave or shipwreck, or from a decompression requirement, adds significant risk. Have a plan to handle to failures and never rely solely on a single source of information.

Decompression stops will appear in place of the safety stop when required. After the decompression stops are completed, the safety stop will begin.

Decompression stops occur at fixed 10ft (3m) intervals.

Decompression stops display as follows:

### Replaces Safety Stop

Once the NDL reaches zero, Deco Stops will replace the Safety Stop display.



### Approach Indicator

As you approach within 17ft (5.1m), the title will change from red to yellow, and an up-arrow will indicate to ascend to the stop.



### At Deco Stop

While at the stop depth or up to 5ft (1.5m) deeper, the title will turn green and a check mark will be shown. Hold this depth until stop time clears.



### Deco Stop Violation

If you violate the deco stop, the display will flash red, and an arrow will indicate to descend. Significant stop violations will result in a “Missed Deco Stop” error.



### Deco Stops Complete

Once all decompression stops are complete, the safety stop will begin counting down. If safety stops are turned off, the display will say “Complete”



### No lock-out for violating deco stops

There is no lock-out or other penalty for violating the decompression stops.

The policy is to provide clear warnings that the decompression schedule was violated, to allow you to make decisions based upon your training.

This may include contacting your dive insurance provider, contacting the nearest hospital or recompression chamber, or performing first aid based upon your training.





## 7. Menu Reference

From the main screen, menus are accessed by pressing the MENU (left) button.

The menu structure is shown in FIGURE 20.

Enter into a menu or execute its command by pressing the CONFIRM (right) button.

### Adaptive Menu

The menu system adapts to the current state of the dive computer. Adaptive menus prevent mistakes and keep the Petrel easy to use.

For example, during a dive the Turn Off, Dive Log, and System Setup menus are not available.

### Menu Timeout

If no buttons are pressed for a period of time, the display times out back to the main screen.

Top-level menus (Turn Off, Select Gas, etc) timeout after 10 seconds. Once inside a menu, the timeout increases to 1 minute.

When a timeout occurs values being edited may not be saved.

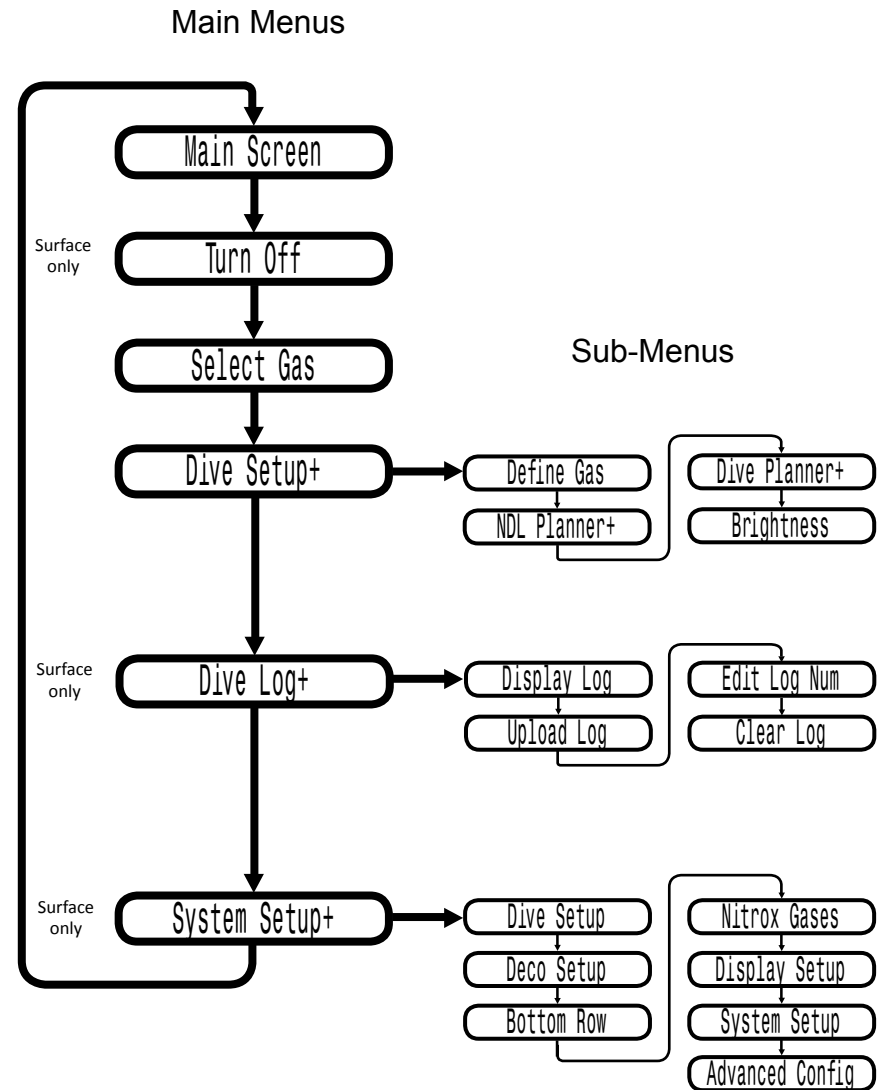

FIGURE 20 **Menu Structure**



## 7.1. Turn Off

Press **CONFIRM** (right) button while displayed to turn off, putting the Petrel in a low power standby state.

The Turn Off menu is not available when diving.



### Automatic Turn Off

When on the surface and no buttons have been pressed for 15 minutes, the Petrel will automatically turn off to save battery life.

## End Dive

This menu item will replace Turn Off when on the surface and still in dive mode.

The Petrel will automatically exit dive mode once 1 minute (default End Dive Delay setting) has been spent at the surface. Use this menu command to exit dive mode sooner.

Adjust the End Dive Delay in System Setup⇒Adv. Config.

## 7.2. Select Gas

The Select Gas menu allows setting the active gas from the list of gases that are currently programmed. Up to three gases may be programmed in the Nitrox Recreational mode.

The active gas has a white background. An off gas is drawn in magenta (purple). Selecting an off gas will automatically turn it on.

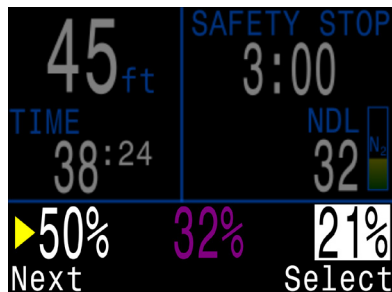

FIGURE 21 **Select Gas Menu**

## 7.3. Dive Setup+

The sub-menus in Dive Setup are available both on the surface and while diving (unlike System Setup which is not available while diving).

### Define Gas

The Define Gas menu appears the same as the Select Gas menu, but allows turning gas on or off, and editing their oxygen percentage (the remaining percentage is assumed to be nitrogen).

Gas may be edited and turned on or off during a dive.

### NDL Planner+

The No-Decompression Limit (NDL) Planner is a quick way to determine how much bottom is available without the need for decompression stops.

It can apply a surface interval from none up to 1 day to account for off-gassing.

NDL Planner		
Depth	NDL	Gas
90ft	33min	Nx32
100ft	25min	Nx32
110ft	20min	Nx32
120ft	10min	Air
Quit		More

FIGURE 22 **NDL Planner Results**

The results are a list of depths, along with the NDL time at that depth and the gas used. Only programmed gas are used.

### Dive Planner+

The Dive Planner is for planning decompression dives. It is covered in the technical version of the manual *Shearwater Petrel Operations Manual, Stand Alone & EXT Models*.

### Brightness

See System Setup⇒Display Setup for brightness options.



## 7.4. Dive Log+

Use the Dive Log menu to review logs stored on the Petrel. Up to 1000 hours of diving can be stored. The dive log sampling rate is one sample every 10 seconds.

The Dive Log menu is only available when on the surface.

### Display Log

Use this menu to display a list of logged dives and view details.

### Upload Log

Selecting this menu item starts the Bluetooth connection and then waits for commands from a desktop or laptop computer.

Once the 3 minute countdown has begun, go to the Shearwater Desktop software and select Dive Computer⇒ Download Dive Log.

### Edit Log Number

Edit the number for the next recorded dive log. Has no effect on already logged dives.

The next dive will be the value entered here plus 1. For example, if 40 is entered here, the next dive will be logged as dive # 41.

### Clear Log

Clear all logs so they will not appear in the Petrel dive log and will not upload to a computer.

## 8. System Setup+

The System Setup menu is only available when on the surface.

### 8.1. Dive Setup

#### Mode

The only mode covered by this manual is OC Rec (the Nitrox Recreational Mode). See the manual *Shearwater Petrel Operations Manual, Stand Alone & EXT Models* for technical modes.

#### Salinity

Water type (salinity) affects how the measured pressure is converted to depth.

Available Salinity settings:

- Fresh
- EN13319
- Salt

Fresh and Salt water differ by about 3%. Salt water, being denser, will display a shallower depth for the same measured pressure versus the Fresh water setting.

The EN13319 value is between Fresh and Salt. It is from the European CE standard for dive computers, and is the Petrel's default value.

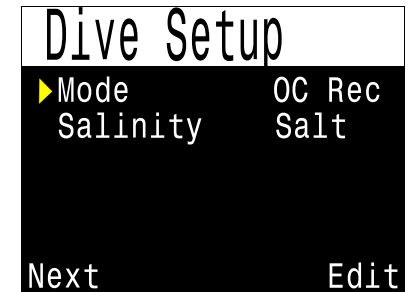



## 8.2. Deco Setup

The only deco model available in Nitrox Recreational mode is Bühlmann ZHL-16C with Gradient Factors.

Deco Setup	
Bühlmann GF ZHL - 16C	
Conservatism	Med
	GF 40/85
Last Stop	10ft
Safety Stop	3min
Next	Edit

### Conservatism

The decompression model conservatism can be set to three fixed levels:

- Low (45/95)
- Med (40/85)
- High (35/75)

The corresponding gradient factors are shown for reference, but cannot be edited directly.

Low conservatism means longer NDL times and less decompression. High conservatism means shorter NDL times and more decompression.

The Low setting is similar to PADI and NOAA no-stop time tables for air and nitrox diving.

### Safety Stop

The Safety Stop setting can be set to the following values:

- Off
- 3 minutes
- 4 minutes
- 5 minutes
- Adapt

When using the Adapt setting, a 3 minute safety stop will be used, unless the dive exceeds 100ft (30m) or the NDL falls below 5 minutes, in which case a 5 minute safety stop is used.

## 8.3. Bottom Row

Configure and preview the bottom row in this menu.

The left position always displays the current gas.

The center and right positions are user configurable, with the following settings available:

Bottom Row		
▶ Center	PPO2 & CNS	
Right	TTS	
Air	PO2 1.08 CNS 15%	TTS 9
Next		Edit

Setting	Description
None	Blank (default for center position).
TTS	Time To Surface. The time in minutes to ascend to the surface, including ascent, deco stops, and safety stops
CNS	Central Nervous System (CNS) oxygen toxicity clock as a percentage.
PPO2	The partial pressure of oxygen in units of absolute atmospheres [ata].
MOD	Maximum Operating Depth of the current gas. Note the MOD is limited by both PPO2 and the Max. Depth setting in Adv. Config.
Temp.	Temperature.
Clock	The time-of-day in 24hr or am/pm format (same as system setting). Does not show "am" or "pm".
Max Depth	The maximum depth of the current (or previous dive when on surface).
Temp & Time	Temperature and Clock, in a smaller font.
PPO2 & CNS	PPO2 and CNS, in a smaller font.
Max. & Avg.	Maximum and Average Depth, in a smaller font.



## 8.4. Nitrox Gases

This page is used to define up to 3 nitrox gases.

Note that gases may also be edited (even during a dive) in the Dive Setup menu. However, the maximum operating depth PPO2 setting cannot be edited in Dive Setup.

Each gas can be set from 21% O<sub>2</sub> to 99% O<sub>2</sub>. The remaining percentage is assumed to be nitrogen.

The active gas is shown with a leading 'A'. A gas that is turned off is drawn in magenta (purple).

The maximum operating depth (MOD) values are not editable directly.

The MOD is determined by two values: The MOD PPO2 setting on this page, and the Max. Depth setting in the Adv. Config. menu.

The shallower of the two MOD limits is used. When the Max Depth setting is the controlling factor, the MOD is displayed grayed-out. In the above example, the air (21%) MOD is controlled by the Max Depth setting. The 32% and 50% nitrox mixes have MOD controlled by the PPO2 MOD setting of 1.4 ata.

MOD PPO2 can be set from 1.2 to 1.6 in steps of 0.1.

Nitrox Gases			
#	On	O2%	MOD
▶ 1	On	50%	60ft
2	Off	32%	112ft
A3	On	21%	130ft
MOD	PPO2		1.4
Next			Edit

## 8.5. Display Setup

### Units

Two options are available:

**Feet:** Imperial units (depth in feet, temperature in °F)

**Meters:** Metric units (depth in meters, temperature in °C)

### Brightness

Screen brightness can be set to three fixed levels or an automatic setting that measures ambient light to optimize brightness.

Lower brightness results in longer battery life.

### Altitude

The Altitude setting is fixed at the Auto setting, which automatically compensates for surface pressure regardless of whether diving at sea level or high altitude.



### Turn the Petrel on before diving

Although the Petrel will turn on automatically (after 45 seconds at a depth exceeding 9ft or 3m), the best practice is to always turn on the dive computer manually. Besides being an opportunity to check functionality, setup, and battery level, it is especially important when diving at altitude in order to accurately determine the surface pressure.

### Flip Screen

Use when wearing the Petrel on the right arm, when a fixed cable is attached to the Petrel (rebreather only).

Display Setup	
▶ Units	Feet
Brightness	Auto
Altitude	Auto
Flip Screen	
Next	Edit



## 8.6. Compass Setup (Petrel 2 only)

### Compass View

The Compass View setting can be set to:

**Off:** The compass is disabled and the Mark Compass option is removed from the menus.

**60°, 90°, or 120°:** Sets the range of the compass dial that is visible on the main screen. The actual amount of arc that is shown on the screen is 60°, so this may feel the most natural. The 90° or 120° setting can be used to see a wider range.

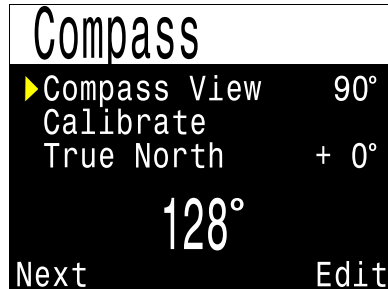

### True North

In most locations, a compass does not point towards True North but rather towards Magnetic North. The difference in angle between these two directions is called the magnetic declination (or sometimes magnetic variation), and varies around the world. The declination in your location can be found on maps or by searching online.

This setting can be set from -99° to +99°.

If you only need to match an uncompensated compass, or your navigation is all based on relative directions, then this setting is not necessary and can be left at 0°.

### Calibrate

Calibration of the compass may be needed if the accuracy drifts over time or when the battery is changed. Each battery has its own magnetic signature, so recalibrating when the battery is changed is recommended.

Compare the Petrel with a known good compass or fixed references to determine if calibration is needed. If comparing against fixed references, remember to consider the local deviation between Magnetic North and True North (declination).

Calibration is typically not needed when traveling to different locations. The adjustment needed then is the True North (declination).

When calibrating, rotate the Petrel smoothly through as many 3D twists and turns as possible in 15 seconds.



#### Compass Calibration Tips

The following tips will help ensure a good calibration.

- Stay away from metal (especially steel or iron) objects. For example, wrist watches, metal desks, boat decks, desktop computers, etc. can all interfere with the Earth's magnetic field.
- Rotate to as many 3D positions as possible. Upside down, sideways, on edge, etc.
- Compare with another compass (not a smartphone, those are terrible) to check your calibration.



## 8.7. System Setup

### Date & Time

The current date. Can be viewed in the info screens and is used to date the dive logs.

Time can be set to either 24-hour format or am/pm format.

### Unlock

Used to unlock purchased features. Currently the only feature that can be unlocked is the VPM-B decompression model. Note, however, that VPM-B cannot be used with the Nitrox Recreational Mode.

### Load Upgrade

Starts the Bluetooth connection, then waits for commands from Shearwater Desktop program. Once the countdown has started on the Petrel, use the Dive Computer⇒Update Firmware option in Shearwater Desktop to send the new .swfw firmware file.

### Reset to Defaults

Opens a sub-menu with options to reset the settings only, the decompression tissues only, or both the settings and decompression tissues. Resetting the settings does not affect the dive logs or system time and date.

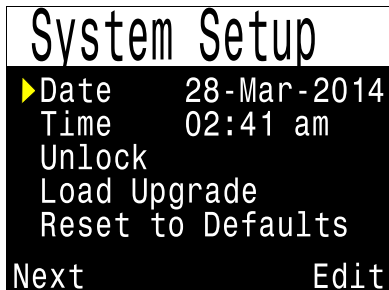

## 8.8. Adv. Config.

The Advanced Configuration contains settings that will not change often,

### Main Color

Options are White or Green.

### Title Color

Options are Blue, Gray, White, Green, and Cyan.

### End Dive Delay

Sets the time in seconds to wait after surfacing before ending the current dive. This value can be set from 20 seconds to 600 seconds (10 minutes). Default is 60s.

This value can be set to a longer time if you want brief surface intervals connected together into one dive. Some instructors use a longer end dive delay when teaching courses.

### Bat Icon

The behavior of the battery icon can be changed here.

Options are:

**Surf+Warn:** The battery icon displays always when on the surface. During dive it displays only if there is a low battery warning.

**Always:** The battery icon always displays.

**Warn Only:** The battery icon only appears when there is a low battery warning.

### Max. Depth

Used together with the MOD PPO2 setting to determine a gas's MOD. The shallower of this value and the depth determined from the PPO2 sets the MOD. Can be set from 100ft to 165ft (default is 130ft), or 30m to 50m (default 40m).

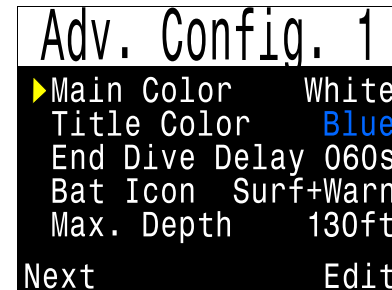





## 9. Changing the Battery

NOTE: A large coin or washer is required for this section.

### Turn off the Petrel

It is a good practice to turn off the Petrel before removing the battery. If removed while on, then there is a small chance (about 1 in 5000) that the deco tissues will be corrupted. The Petrel detects this using a cyclic redundancy check (CRC), so there is no danger. However, the tissues will be lost and repetitive dives will need to be planned accordingly.

### Remove the battery cap

Insert the coin or washer into the battery cap slot. Unscrew by turning counter clockwise until the battery cap is free. Be sure to store the battery cap in a clean dry space.

### Exchange the battery

Remove the existing battery by tilting the Petrel computer. Insert the new battery positive contact first. A small diagram on the bottom of the Petrel shows the proper orientation.

### Accepted battery types

The Shearwater Petrel can accept a wide variety of AA sized batteries. The Petrel can accept any AA sized (or 14500 size) battery that outputs a voltage between 0.9V and 4.3V.

### Reinstalling the battery cap

It is very important that the battery cap O-ring is clear of dust or debris. Carefully inspect your O-ring for any debris or damage and gently clean. It is recommended that you lubricate your battery cap's O-ring on a regular basis with an O-ring lubricant compatible with Buna-N (Nitrile) O-rings. Lubricating helps ensure that the O-ring seats properly and does not twist or bunch.

Insert the battery cap into the Petrel and compress the battery contact springs. While the springs are compressed rotate the battery cap clockwise to engage the threads. Be sure not to cross thread the battery cap's threads. Tighten the battery cap until snug. Do not over tighten the battery cap.

NOTE: Battery cap O-ring is Type 112 Buna-N 70 durometer.

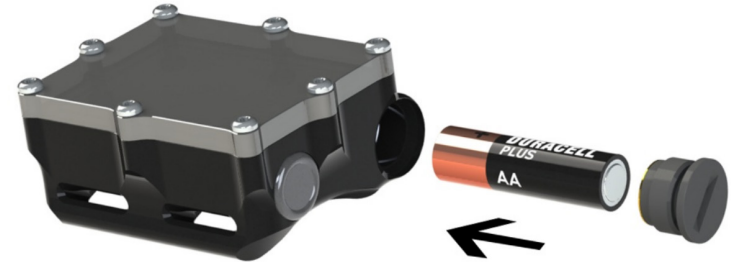

FIGURE 23 *Changing the Battery*

## 9.1. Battery Types

After changing the battery, a screen will prompt for the battery type to be entered.

The Petrel attempts to guess what type of battery is being used. If the battery type is incorrect, it should be manually edited.

Having the battery type set correctly is important so that the Petrel can give low battery warnings at the proper voltage levels.

Supported battery types are:

**1.5V Alkaline:** The common AA battery type that can be purchased at most supermarkets and electronics stores around the world. Not rechargeable. Inexpensive and reliable, they provide 35 hours of operation. Recommended.

**1.5V Photo Lithium:** Fairly common, but more expensive



than alkalines. They provide about 55 hours of operation. Not rechargeable. Good for use in very cold water. Recommended.

**1.2V NiMH:** Common rechargeable batteries used in digital cameras and photo flashes. Can have high self discharge. Provide about 30 hours of operation per charge. Can die quickly, so care should be taken to ensure sufficient charge prior to diving.

**3.6V Saft:** The Saft LS14500 lithium batteries provide very high energy density. However, their high cost makes other battery types a better choice for most users. Provide about 100 hours of operation. Can die quickly, so care should be taken to ensure sufficient charge prior to diving.

**3.7V Li-Ion:** Rechargeable 14500 Li-Ion batteries provide about 35 hours of operation per charge. Can be ordered from the internet. Have more gradual voltage drop as discharged, so easier to determine remaining capacity than NiMH rechargeables. Good in cold water.

NOTE: Battery operating lifetimes are given with screen on medium brightness and at room temperature. Higher brightness and lower temperature can reduce life. Lower brightness can increase life.



### Remove Batteries for Storage

Batteries can leak, especially when discharge. Do not risk damaging your dive computer by leaving batteries installed for long periods (greater than 3 months).

Alkaline batteries are especially bad for leaking, and are most prone to leaking when completely discharged.

## 9.2. Tissues Cleared

Some conditions will cause the decompression inert gas tissue loadings to be cleared. When cleared, the tissues are set to being saturated with breathing air at the current barometric pressure.

The Petrel does not lock-out when the tissues are cleared. If the tissues are cleared, then the diver must take appropriate cautions when planning repetitive dives. The Petrel clearly notifies when tissues are cleared, so that the diver has the proper information to make responsible decisions.

For example, after changing the battery, you will see one of these two screens:

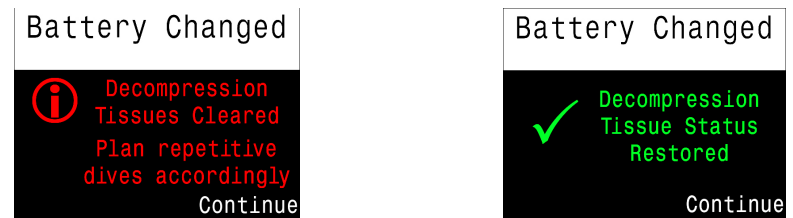

FIGURE 24 **After a battery change, you will be notified if the decompression tissues were restored successfully**

Conditions that cause the tissues to be cleared are:

**Firmware Updates:** A firmware update will clear the tissues. Therefore, updating the firmware in the middle of a dive trip is not a good idea.

**User Request:** You can clear the tissues manually in the System Setup → System Setup menu. Use the Reset To Defaults option. This will then prompt if you want to reset the settings only, the tissues only, or both.

**Slow Battery Change:** Quick battery changes do not normally cause the tissues to be cleared. A super capacitor stores energy to keep the clock running for at least 15 minutes during a battery change. If battery removed for longer than 15 minutes, then the tissues will be cleared.



**Corruption:** A 32-bit cyclic redundancy check (CRC) is used to verify the integrity of the tissues each time the Petrel is turned on. If corrupted, the tissues will be cleared. The most likely cause of corruption is removing the battery with the Petrel turned on. Therefore, turning the Petrel off before changing the battery is the best practice.

**Changing To/From Gauge Mode:** In gauge mode the Petrel does not know what gas you are breathing and cannot track tissue loading. Therefore, when changing to or from gauge mode, the tissues are cleared.

## 10. Storage and Maintenance

The Petrel dive computer should be stored dry and clean.

Do not allow salt deposits to build up on your dive computer. Wash your computer with fresh water to remove salt and other contaminants. **Do not use detergents or other cleaning chemicals** as they may damage the Petrel dive computer. Allow to dry naturally before storing.

Do not wash under high pressure jets of water as it may cause damage to the depth sensor.

Store the Petrel dive computer out of direct sunlight in a cool, dry and dust free environment. Avoid exposure to direct ultra-violet radiation and radiant heat.

## 11. Servicing

There are no user serviceable parts inside the Petrel. Do not tighten or remove the faceplate screws. Clean with water ONLY. Any solvents may damage the Petrel dive computer.

Service of the Petrel may only be done at Shearwater Research, or by any of our authorized service centers.

Your nearest service center can be found at [www.shearwaterresearch.com/contact](http://www.shearwaterresearch.com/contact)

## Glossary

**@+5** - "At Plus 5 Minutes". The TTS if remaining at the current depth for five more minutes.

**CC** - Closed circuit. Scuba diving using a rebreather where exhaled gas is recirculated with carbon dioxide removed.

**CNS** - Central Nervous System (as relates to oxygen toxicity).

**DCI** - Decompression illness.

**EXT** - A Petrel model with external PPO2 monitoring.

**FO<sub>2</sub>** - Fraction of oxygen, sometimes FO2.

**GF99** - "Gradient Factor to 99%". The Bühlmann ZHL-16C supersaturation percent gradient.

**MOD** - Maximum Operating Depth. The deepest depth to which a gas may be safely used.

**NDL** - No Decompression Limit.

**N<sub>2</sub>** - Nitrogen.

**O<sub>2</sub>** - Oxygen.

**OC** - Open circuit. Scuba diving where gas is exhaled into the water (i.e. most diving).

**Petrel** - This dive computer. Also, a type of seabird closely related to the Shearwater (another seabird). Some species are active Predators, diving deep underwater in Pursuit of a meal.

**PPO<sub>2</sub>** - Partial Pressure of Oxygen, sometimes PPO2.

**SC** - Semi-closed circuit. Scuba diving using a rebreather where some of the exhaled gas is recirculated with carbon dioxide removed.

**TTS** - Time To Surface. The time to ascend to the surface including the ascent, decompression stops, and the safety stop.



# Specifications

Specification	Standalone (SA) Model	External PPO2 (EXT) Model
Operating Modes	OC Tec / OC Rec OC/CC (internal PPO2) Gauge	OC Tec / OC Rec OC/CC (internal PPO2) OC/CC (external PPO2) OC/SC (external PPO2) Gauge / PPO2
Decompression Model	Bühlmann ZHL-16C with GF VPM-B and VPM-B/GFS (optional, not available in OC Rec mode)	
Pressure (depth) sensor	Piezo-resistive	
Range	0 Bar to 14 Bar	
Accuracy	+/-20 mBar (at surface) +/-100 mBar (at 14bar)	
Crush Depth Limit	30 Bar (~290msw)	
Surface Pressure Range	500 mBar to 1080 mBar	
Depth of dive start	1.6 m of sea water	
Depth of dive end	0.9 m of sea water	
Operating Temperature Range	+4°C to +32°C	
Short-Term (hours) Temperature Range	-10°C to +50°C	
Long-Term Storage Temperature Range	+5°C to +20°C	
Battery	AA Size, 0.9V to 4.3V	
Battery Operating Life (Display Medium Brightness)	35 Hours (AA 1.5V Alkaline) 100 Hours (SAFT LS14500)	
External Connector Socket	N/A	Fischer 103, 7-pin
External O2 Sensor Type	N/A	"10mV in air" Type: Zero offset Linear response to PPO2 Temp. comp. in sensor Common negative Range 0mV to 100mV
External O2 Sensor Input Resistance	N/A	100kΩ
Weight	0.4kg	
Size (W X L X H)	84mm X 74mm X 38mm	100mm X 74mm X 38mm

# FCC Warning

**a) USA-Federal Communications Commission (FCC)**

This equipment has been tested and found to comply with the limits for a Class B digital device, pursuant to Part 15 of FCC Rules. These limits are designed to provide reasonable protection against harmful interference in a residential installation. This equipment generates, uses, and can radiate radio frequency energy. If not installed and used in accordance with the instructions, it may cause harmful interference to radio communications. However, there is no guarantee that interference will not occur in a particular installation.

If this equipment does cause harmful interference to radio or television reception, which can be determined by tuning the equipment off and on, the user is encouraged to try and correct the interference by one or more of the following measures:

- Reorient or relocate the receiving antenna
- Increase the distance between the equipment and the receiver.
- Connect the equipment to outlet on a circuit different from that to which the receiver is connected.
- Consult the dealer or an experienced radio/TV technician for help.

Any changes or modifications not expressly approved by the party responsible for compliance could void the user's authority to operate the equipment.

**Caution: Exposure to Radio Frequency Radiation.**

This device must not be co-located or operating in conjunction with any other antenna or transmitter.

Contains TX FCC ID: T7VEBMU

# Industry Canada Warning

**b) Canada - Industry Canada (IC)**

This device complies with RSS 210 of Industry Canada.

Operation is subject to the following two conditions:

- (1) this device may not cause interference, and
- (2) this device must accept any interference, including interference that may cause undesired operation of this device.

L'utilisation de ce dispositif est autorisée seulement aux conditions suivantes :

- (1) il ne doit pas produire d'interférence, et
- (2) l'utilisateur du dispositif doit être prêt à accepter toute interférence radioélectrique reçue, même si celle-ci est susceptible de compromettre le fonctionnement du dispositif.

**Caution: Exposure to Radio Frequency Radiation.**

The installer of this radio equipment must ensure that the antenna is located or pointed such that it does not emit RF field in excess of Health Canada limits for the general population; consult Safety Code 6, obtainable from Health Canada's website [www.hc-sc.gc.ca/ewh-semf/pubs/radiation/radio\\_guide-lignes\\_direct-eng.php#sc6](http://www.hc-sc.gc.ca/ewh-semf/pubs/radiation/radio_guide-lignes_direct-eng.php#sc6)

Contains TX IC: 216QEbzzMU