

SEA&SEA

03116
03541

UNDERWATER STROBE



YS-03

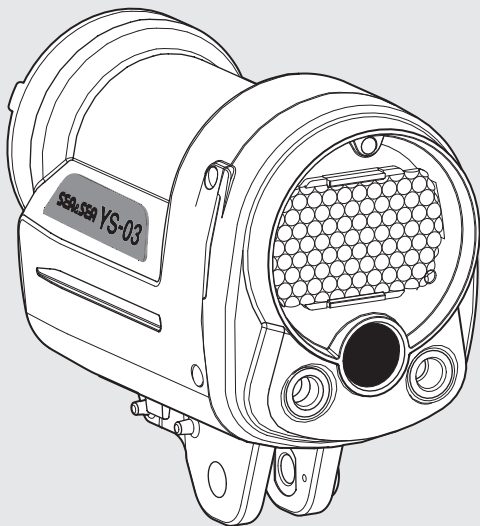

日本語

English

取扱説明書
Instruction Manual

Introduction

Thank you for purchasing SEA&SEA products.

Please read this instruction manual carefully prior to using your underwater strobe. Only with a thorough understanding of this manual's content will you be able to use the strobe correctly. After reading the manual, please be sure to keep it in a place where you can easily come back to it at any time.

Note:



Products bearing this sticker are those that have passed SEA&SEA's criteria-based inspection for pressure resistance.



This device complies with Part 15 of the FCC Rules. Operation is subject to the following two conditions: (1) this device may not cause harmful interference, (2) this device must accept any interference received, including interference that cause undesired operation.



The product conforms to WEEE standards. This symbol indicates separate collection of waste electrical and electronic equipment in the EU countries. Please do not throw the equipment into the domestic refuse. Please contact your local authorities for recycling program information.

The appearance of color evenness or weld lines on the external body of the product is normal and will not affect its performance.

Contents

Safety Precautions	E-3
Safety Precautions for Use of Battery	E-6
Accessories	E-8
Identification of Parts	E-9
Operation	E-10
Fiber-optic cable socket (for additional strobe) ...	E-11
Ready lamp	E-11
Fixing Bolt	E-11
Installing the Batteries	E-12
Connecting the Strobe	E-14
When using as a sub-strobe	E-15
Taking Photographs	E-16
TTL photography	E-16
Using the Diffuser	E-17
Maintenance and Storage	E-19
Specifications	E-20

Safety Precautions

SEA&SEA strobes have been designed for in-water use only. Limit the strobes use out of water to test firing only.

For safe handling of the product, please read the following precautions carefully before use.

Failure to heed the precautions listed below could result in serious consequences. To prevent injury or damage to yourself and/or others, please observe the precautions as they contain highly important information related to personal and product safety.

 **DANGER** Situations that involve a high risk of severe injury or death.

 **WARNING** Situations that could result in severe injury or death.

 **CAUTION** Situations that could result in property damage or personal injury.

DANGER

- Never attempt to disassemble, repair or alter the product yourself to prevent significant electrical hazard due to the high-voltage circuitry in the product. Do not heat the product or put it into a fire, this could result in explosion or fire. Unauthorized disassembling and/or modification could result in malfunction or flooding, and void product warranty. Take the product to a SEA&SEA authorized service center for repair or inspection.

WARNING

- Use only batteries approved for use in this product. Do not mix old and new batteries of different types.
- Remove batteries before transport or storage, or when you are not going to use the product for an extended period of time, to prevent unexpected activation.
- Pay particular attention to opening the battery cap to avoid injury. Heat from the batteries may cause pressure buildup inside the battery compartment, and could result in cap explosion with unexpected force.
- Prevent water or foreign objects from entering the product. Discontinue use and turn it off immediately should you notice flooding or leakage. Continuous use could result in complete damage to the product.
- Do not handle batteries with wet hands to prevent shock hazards.
- Do not use the product in the presence of flammable gas, as this could result in explosion or fire.
- Do not fire the strobe/light with the reflector facing a desk or floor to prevent a fire from occurring. Touching the reflector immediately after firing could result in burns.

- Do not fire the strobe or illuminate the light towards a driver of a vehicle to avoid causing accidents.
- Do not operate the product while driving a vehicle. Inattention could result in accidents.
- For use on land, do not operate the product at precarious foothold. It may cause falling, injury or product damage.
- Do not leave the product on a slope or an unstable surface. It may be broken after falling or injure someone below it.
- Keep out of reach of children to prevent accidental ingestion. If swallowed, seek medical advice immediately.

CAUTION

- Read the instruction manual and observe proper precautions before use of this product.
- This product has been designed and manufactured for use at a water depth within 75m / 250ft. Please note that diving to a depth in excess of 75m / 250ft may cause damage to the product or may lead to water leakage.
- Should you notice smoke or unusual smell coming from the product, turn it off and remove the batteries immediately, taking care to avoid burns. Continued operation could result in injury. After removing the battery, take the product to a SEA&SEA authorized service center for inspection.
- Discontinue use and turn the product off immediately should you notice flooding or leakage.
- When the product is flooded, interior pressure may build up. Please be careful when opening the product as water may spurt out or the cap may open explosively and cause injuries.
- Do not open the battery cap in the vicinity of open flames.
- The product has been constructed with an airtight seal. When packing the product for airplane travel, do not seal-up the product to alleviate pressure build up due to atmospheric changes.
- Do not open the product in a wet or sandy environment. Protect the interior from moisture and debris in order to prevent malfunction or flooding.
- Keep away from strong magnetic fields. Do not use or store this product in the vicinity of equipment that generates strong electro-magnetic radiation or magnetic fields. Strong static charges or the magnetic fields could cause malfunction, or affect the product's internal circuitry.
- Before using the product in an airplane or a hospital, check if it is allowed. Electromagnetic waves emitted by the product may interfere with the measuring instruments or medical equipment.
- Do not cover or wrap the product with a cloth when firing the strobe. This could result in deformation of the product or in fire.

Safety Precautions

- Using the strobe close to your subject's eyes could cause temporary visual impairment. Particular care should be observed if photographing infants, the strobe should be no less than one meter (3 feet) from the subject.
- Be careful when touching the product immediately after firing repeatedly or lighting for a long time. The product may get hot enough to burn you.
- Avoid strong shocks / impacts or excess stress to prevent malfunction, damage or breakdown. Make sure that the product has been securely mounted to other products in order to prevent injury, fall or missing.
- Do not carry the camera or housing by holding the accessories such as arm, cable, strobe, etc. Heavy components may fall and cause damage or injury.
- Do not rest heavy weight on the product. It might deform the outer casing, damage internal parts, make the waterproofing fail, or result in fire or electric shock.
- Rinse the product with fresh water, after underwater use. Ensure that the product is watertight before rinsing. Refer to [Maintenance and Storage] for details.
- Never use chemicals, cosmetics, any petroleum solvents such as paint thinner, or neutral detergent on the product. They may deform and damage the product.
- Do not leave the product in places with hot temperatures such as inside of a car or in a car trunk in summer. The heat may deform plastic parts of the product, damaging internal parts and resulting in potential fire or electric shock. If the product is sealed tight in hot conditions, heated air expanding inside the product may deform the casing and ruin the watertightness.
- Do not store the product in wet or high-humidity place, to avoid mold, rust, corrosion or malfunction.
- Do not store the product with naphthalene or camphor mothballs, or in locations such as a laboratory where chemicals are used. This environment can cause mold, rust, corrosion or malfunction.
- If you do not use the product for an extended period of time, periodic maintenance will keep internal electronic parts from deterioration. Once a month, install batteries and fire a test flash / light on. Operate all other switches as you would in normal operation. Turn the power off, then remove batteries while the Ready lamp (red) is on for the strobe.
- SEA&SEA SUNPAK Co., Ltd. assumes no liability for compensation of loss of captured images or expenses caused by loss of images, even if you are unable to shoot due to a product defect or malfunction.
- SEA&SEA SUNPAK Co., Ltd. will not be responsible for the replacement or compensation for cameras, lenses or those accessories damaged due to your invalid operation.
- Carefully observe the O-ring maintenance manual for the handling of O-rings before use.

- SEA&SEA SUNPAK Co., Ltd. assumes no liability for errors or discrepancies in this manual.
- Specifications and appearance are subject to change without notice.
- The silicon grease included in the product package is inedible.

Safety Precautions for Use of Battery

DANGER

- Never expose the battery to flame or fire, or to excessive heat.
- Never attempt to disassemble, alter or directly solder the battery. There are no user-serviceable parts. Tampering with battery may expose you to dangerous voltage, battery acid, or electrical shock.
- Never short-circuit the terminals of a battery, as it could result in battery leakage, heat generation, fire, or explosion. Avoid contact with all metal objects during transporting and storage.
- When recharging batteries such as nickel metal-hydride, use a charger designed specifically for them and follow the recharging instructions. Recharging with an inappropriate charger may cause battery leakage, overheating, and explosion.
- Move leaking batteries away from fire or open flames immediately. The leaked fluid and its vapor are combustible.
- If the battery leakage contacts your skin or clothing, flush the affected area repeatedly with clean water. It may irritate your skin.
Should it get into your eyes, immediately rinse them with plenty of water, avoid rubbing and seek medical advice.
- Battery has a specific polarity. Never force the battery into the charger or the strobe. Always check the + and - polarity before installation.
Incorrect orientation may cause permanent battery damage.
- Never connect a battery directly to a plug outlet or car cigarette lighter.

WARNING

- Keep dry. The battery is not waterproof, and may malfunction if immersed in water or exposed to high levels of humidity. Rusting of the internal mechanism can cause irreparable damage.
- Do not remove and/or damage the case of a battery. It may cause battery leakage, overheating or explosion.
- Do not charge a rechargeable battery beyond the specified charging time, it may cause battery leakage, fire hazard or explosion.

Safety Precautions for Use of Battery

- Never use batteries should you notice any changes such as leakage, discoloration or deformation. When you notice the situation as abnormal, discontinue use immediately and take the product to a SEA&SEA authorized service center for inspection.
- Keep out of reach of children to prevent accidental ingestion. If swallowed, seek medical advice immediately.
- Do not leave or use batteries in an extreme hot environment. This may cause battery leakage, overheating or battery performance deterioration.
- Do not use non-recommended batteries (such as lithium primary batteries). Use of non-recommended batteries may cause battery leakage and overheating and may cause the strobe to rupture, which could result in personal injury.

CAUTION

- Avoid strong shocks / impacts or excess stress to batteries.
- For handling and recharging of a battery, refer to the instruction manual of the battery/dedicated charger.
- Do not use or discharge the battery at ambient temperatures below 0°C (32°F) or above 50°C (122°F).
- During recharging, the temperature should be in the vicinity from 0°C to 40°C (32°F to 104°F).
- Always recharge the rechargeable battery before use after an extended time of storage.
- Do not recharge battery in a cold environment below 0°C (32°F). Severe cold may cause battery leakage, deterioration in performance, or shortened life.
- Dirt on the battery terminals can prevent the product from functioning. Should the battery terminals become dirty, wipe them with a clean, dry cloth before use.
- Turn the equipment off after use. Remove batteries from the equipment when not in use. Store in dry area with temperatures ranging from -20°C to 30°C (-4°F to 86°F).
- Used rechargeable batteries are valuable resource. Please recycle used rechargeable batteries in accordance with local regulations.

Accessories

Before using this model, check to make sure that all accessories are present.

YS-03

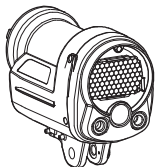

Diffuser



Diffuser Strap



Sillicon Grease



Fixing Bolt



- O-ring Maintenance Manual
- YS-03 Instruction Manual (this manual)

Identification of Parts

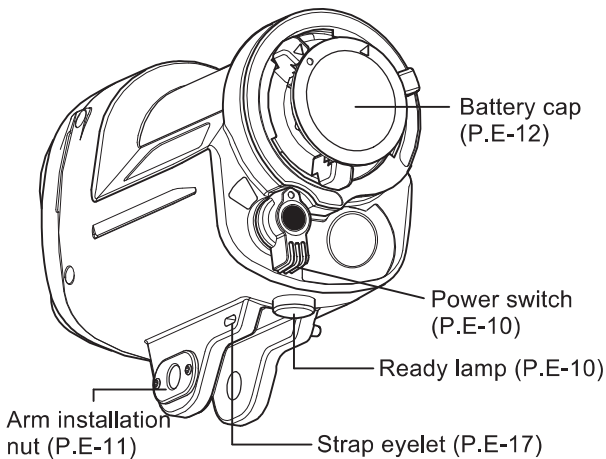
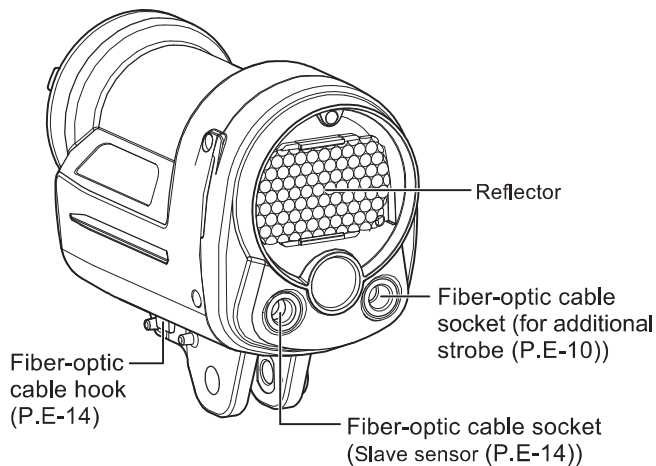

Operation

Power Switch

- OFF** Turns the power off. Set the mode switch to [OFF] when you are not using the strobe.
- TTL** Set the mode switch to this position when you take a photography.

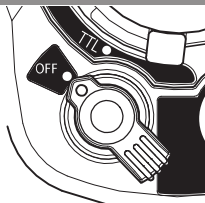

Fiber-optic cable socket (for additional strobe)

The fiber-optic cable socket (for additional strobe) is not a slave sensor. When using this strobe as a main strobe etc., an additional strobe may be fired using the second fiber optic socket.

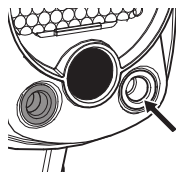

Ready lamp

Illuminates in red when the strobe is ready to fire.

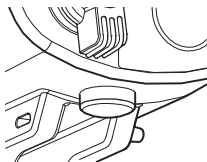

Fixing Bolt

To mount the strobe to an arm, insert the fixing bolt in the direction of the arrow.

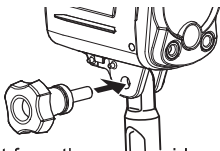

CAUTION

- Take care not to insert the fixing bolt from the wrong side, as this can result in damage to the arm installation nut.
- Do not tighten the fixing bolt up on the product unless it is being attached to an arm.
- Remove the fixing bolt from the product when storing.

Installing the Batteries

Be careful when opening the strobe battery compartment. Remove the battery cap in a horizontal position to prevent water drops from entering the battery compartment.

This model can be powered by the following batteries.

Use four of each type.

AA alkaline battery, AA Ni-MH battery

- 1 **Make sure that the power switch is in the OFF position**
- 2 **Turn ∇ mark counterclockwise to the OPEN \circ position**

- 3 **Pull the battery cap straight out**

- When open a battery cap, always pull battery caps sideways.



Fig.1

- 4 **Insert four batteries with the polarity shown in the battery compartment.**

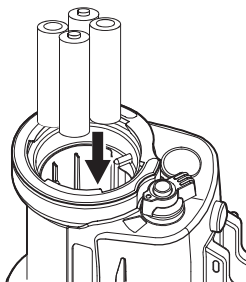
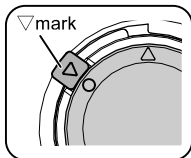

Fig.2

- 5 **Verify that the ○ mark on the battery cap is lined up with the ▽ mark**



- 6 **Align the battery cap with the OPEN ○ position, and insert the battery cap into the strobe**
● Check the O-ring to make sure there are no scratches or debris.

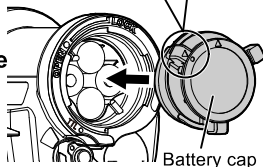

Fig.3

- 7 **Turn ▽ mark clockwise to the LOCK position**
● Turn until you hear the sound of it clicking into place.

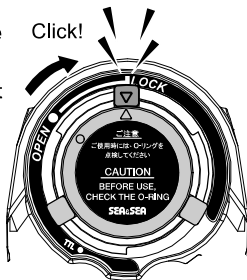

Fig.4

⚠ CAUTION

- Replace the batteries when it takes 30 seconds or more until the Ready/TTL lamp illuminates in red after firing at full.
- When installing or removing batteries, thoroughly wipe water off the strobe and dry your hands. Pay particular attention not to allow water from your hair or wetsuit to drip into the battery compartment. This is in order to prevent an electrical hazard, mold, malfunction or damage to the strobe.
- Never mix old and new batteries or batteries of different types.
- Always replace all batteries with new batteries at the same time.

Connecting the Strobe

When you use this strobe, connect the strobe to the camera (housing) with a fiber-optic cable (optional). Using a built-in slave sensor, this strobe is triggered by sensing the light from a digital camera's built-in flash. If the fiber-optic cable is not used, depending on the shooting conditions the strobe may not fire.

⚠ CAUTION

- Some housings are not compatible with fiber-optic cable.

1 Insert the fiber-optic cable's connector into the fiber-optic cable socket (slave sensor) of the strobe until it stops

- The second fiber optic socket on the right may be used to fire an additional strobe.
Please refer to page E-10 for details.
- Refer to page E-15 when using this strobe as a sub-strobe.

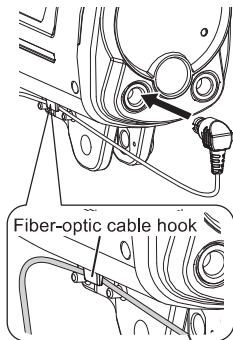

2 Secure the fiber-optic cable with the fiber-optic cable hook

3 Connect the fiber-optic cable's connector to the socket in the housing

- When the housing is not equipped with the socket, attach the optional strobe mask (A) to the flash window of the housing, and then connect the fiber-optic cable (B).

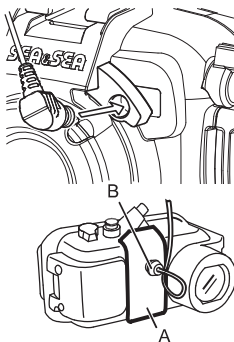

⚠ CAUTION

- When shooting, set the built-in flash of the camera to the forced-flash mode. The strobe will not fire unless the built-in flash of the camera fires. Refer to the digital camera instruction manual for setting the forced-flash mode.
- Refer to the fiber-optic cable instruction manual before use.
- When using this model together with the SEA&SEA DX-8000G/DX-1G/DX-2G set (discontinued products), please attach the fiber-optic cable adapter (included in the DX-8000G/DX-1G/DX-2G) to the housing, and then use a fiber-optic cable.
- Refer to the housing instruction manual before use.

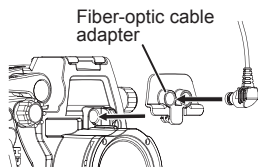

When using the second strobe

The fiber-optic cable socket (for additional strobe) is not a slave sensor. When using this strobe as a main strobe etc., another strobe can be added using a fiber-optic cable.

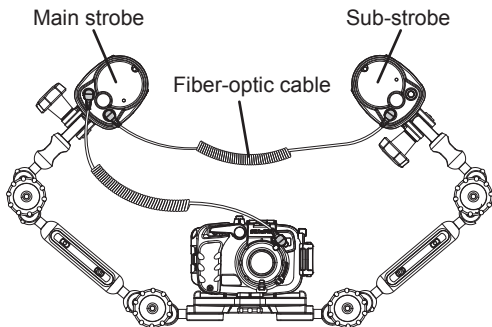

Taking Photographs

When shooting, set the built-in flash of the camera to the forced-flash mode. The strobe will not fire unless the built-in flash of the camera fires.

- Please refer to our website (<http://www.seaandsea.jp>) for the latest information.

TTL photography

The TTL system on this strobe is a slave TTL system with flash dimming functionality. This system is useful for when you are using another main strobe that can pre-flash such as a camera's built-in TTL flash or another TTL strobe that is connected to the camera.

1 Set the power switch to [TTL]

2 Take a photography

Slave TTL

The strobe's slave TTL mimics the camera's built-in flash.

CAUTION

- Slave TTL will function only when you use the camera's built-in flash or other TTL strobe connected to the camera. Slave TTL will not work if the main light source (camera's built-in flash) is not equipped with TTL function, or if the primary light source does not pre-flash, slave-TTL may not function.
- When you shoot, set the built-in flash of the camera to the forced-flash mode. The strobe will not fire unless the camera's built-in flash fires.

Using the Diffuser

Use of the diffuser is highly recommended for macro shooting.

Attaching the diffuser

- 1 **Attach the included diffuser strap to the strap eyelets on the diffuser and the strobe**

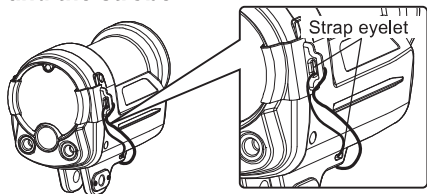

- 2 **Align the notches on the top and bottom of the diffuser with the protrusions on the reflector**
- 3 **Firmly set the tabs on the diffuser into the grooves on the right and left side of the body**

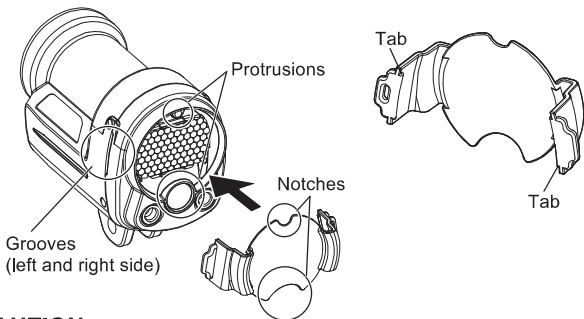

! CAUTION

- Always make sure that the diffuser is properly attached before use. If not properly attached, it may fall off, get lost or become damaged.

Detaching the diffuser

Pinch in and pull up on the tabs (A) simultaneously to remove the tabs from the side grooves.

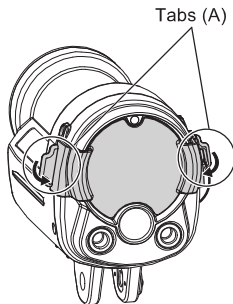
**⚠ CAUTION**

- Do not try to forcibly remove the diffuser with the tab on only one side as doing so may cause breakage.

Note:

- To prevent overexposure in bright environments with a lot of ambient light, adjust the camera's exposure compensation, lower the camera's ISO sensitivity and/or distance the YS-03 further from the subject.
- When images are overexposed, turn off underwater light if used with the strobe.

Maintenance and Storage

⚠ CAUTION

- Never use chemicals, cosmetics, any petroleum solvents such as paint thinner, or neutral detergent on the product. They may deform and damage the product.
- After each use in salt water, make sure the battery and connector caps are attached, then in a watertight condition soak it sufficiently in fresh water.
- Insufficient soaking causes damage by salt to the product.

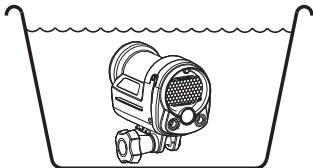

Salty residue may be left on the product where it will crystallize as it evaporates. Crystallized salt is hard to dissolve and difficult to be removed once formed, and it will result in water leakage.

- After rinsing, dry the product well with a soft dry cloth, then let the product dry in the shade, out of direct sunlight.
- Do not dry the product by heating (using a hair dryer, for example). Heating can deform and damage the product.
- If you do not use the product for an extended period of time, store it away from high temperatures, high humidity, direct sunlight, or extreme cold.
- Do not store the product with naphthalene or camphor mothballs, or in locations such as a laboratory where chemicals are used. This environment can cause mold, rust, corrosion or malfunction.
- Always remove batteries from the product after use.
- After using the product, maintain the O-rings before storing. Examine the O-rings before and after each dive. We recommend early exchange of the O-rings, at least once a year.
- Every two years we recommend a complete overhaul of O-rings regardless of the frequency in use, for the best performance of the product.
- If you do not use the product for an extended period of time, periodic maintenance will keep internal electronic parts from deterioration. Once a month, install batteries and fire a test flash. While the Ready lamp is red (strobe is ready to fire), set the power switch to [OFF], then remove the batteries. In addition, operate all other switches as you would in normal operation.

Specifications

Controls and functions	Power switch (OFF / TTL)
Indicator	Ready lamp (Illuminates in red when the strobe is ready to fire.)
Guide number	20 (at full flash) * ISO100/m * Depending on the camera models.
Beam angle	100° × 100° 105° × 105° (with Diffuser)
Color temperature	5600° K (at full flash) 5250° K (with Diffuser)
Battery life	Alkaline : Approx. 230 flashes Ni-MH (2700mAh) : Approx.330 flashes
Recycle time	Alkaline : Approx. 3.1 sec Ni-MH (2700mAh) : Approx.2.5 sec
Battery requirements	4 × AA Alkaline, 4 × AA Ni-MH (2700mAh)
Operating temperature	1°C-40°C / 34° F-104° F
Construction	ABS resin, Polycarbonate resin
Depth rating	75m (250ft)
Dimensions (WxHxD)	68 × 108 × 129mm / 2.7 × 4.3 × 5.2inch
Weight	Approx. 430g / 15.2oz (excl. batteries)
Weight underwater	Approx. 10g / 0.35oz (incl. batteries)

* The specifications and external design are subject to change without notice.

* Number of flashes and recycle time depends on the battery brand, temperature and frequency of use.

* The above specifications were tested at normal room temperature (25°C / 77° F).

* Underwater weight measurements have been taken in fresh water. Sea water weight will vary.